

PLANTA 5
Portal 2 - Letra B

VIVIENDA TIPO 8 / 4D

superficie CONSTRUIDA - C/PPEC: 127,61 M²

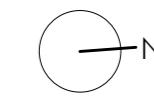

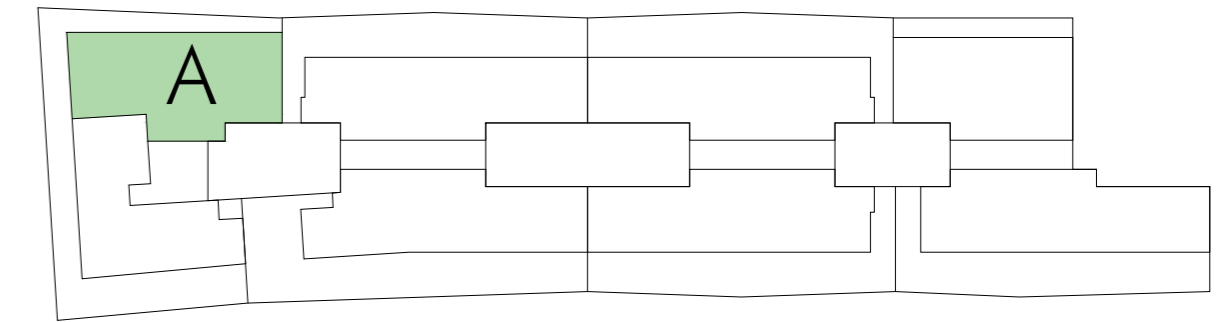

PLANTA 5
Portal 1 - Letra A

VIVIENDA TIPO 13 / 4D

superficie CONSTRUIDA - C/PPEC: 125,28 M²

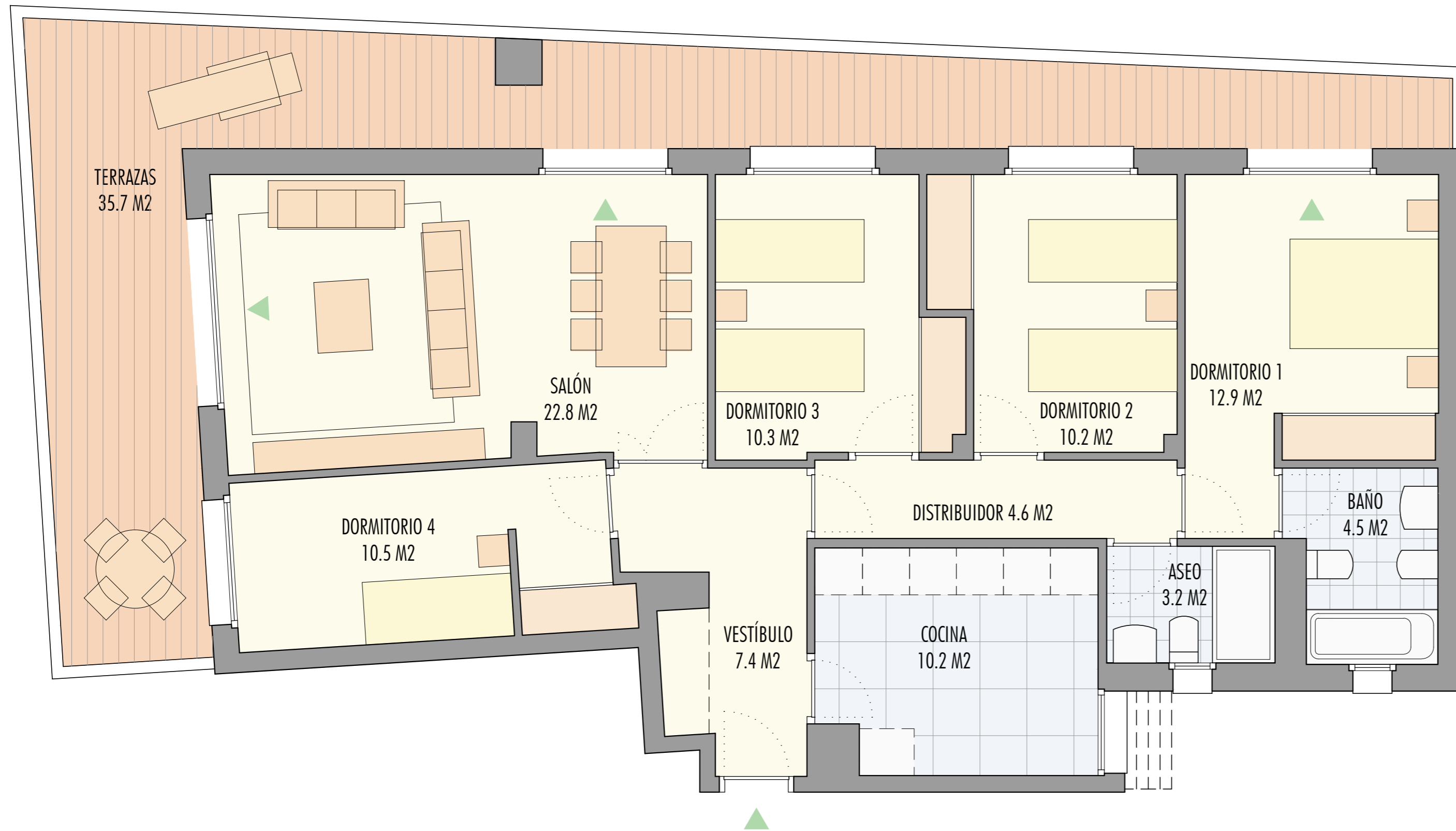

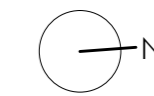
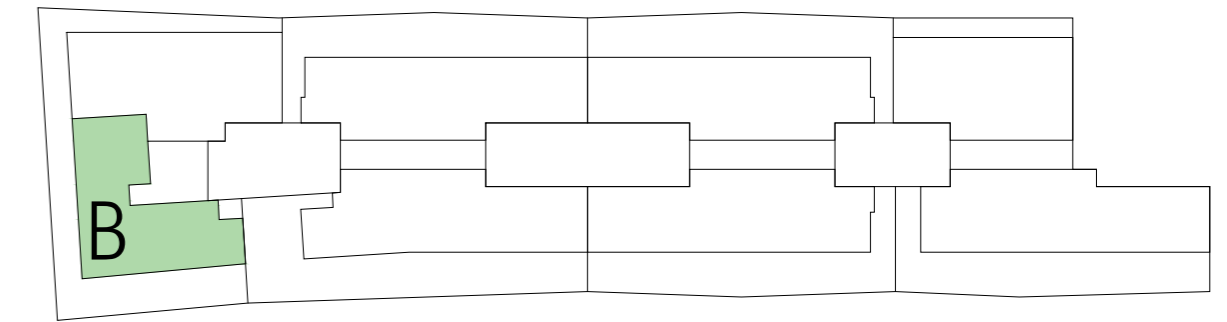

PLANTA 5
Portal 1 - Letra B

VIVIENDA TIPO 14 / 3D

superficie CONSTRUIDA - C/PPEC: 101,16 M²



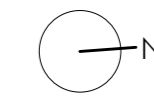
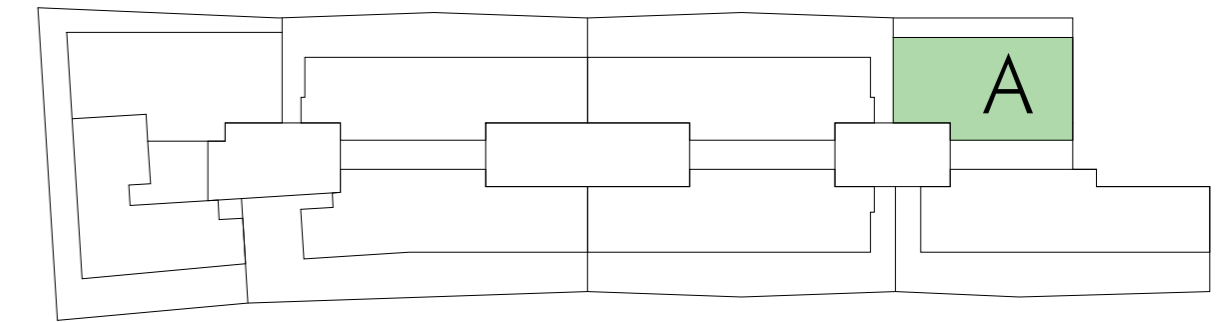

PLANTA 5
Portal 4 - Letra A

VIVIENDA TIPO 15 / 3D

superficie CONSTRUIDA - C/PPEC: 107,25 M²

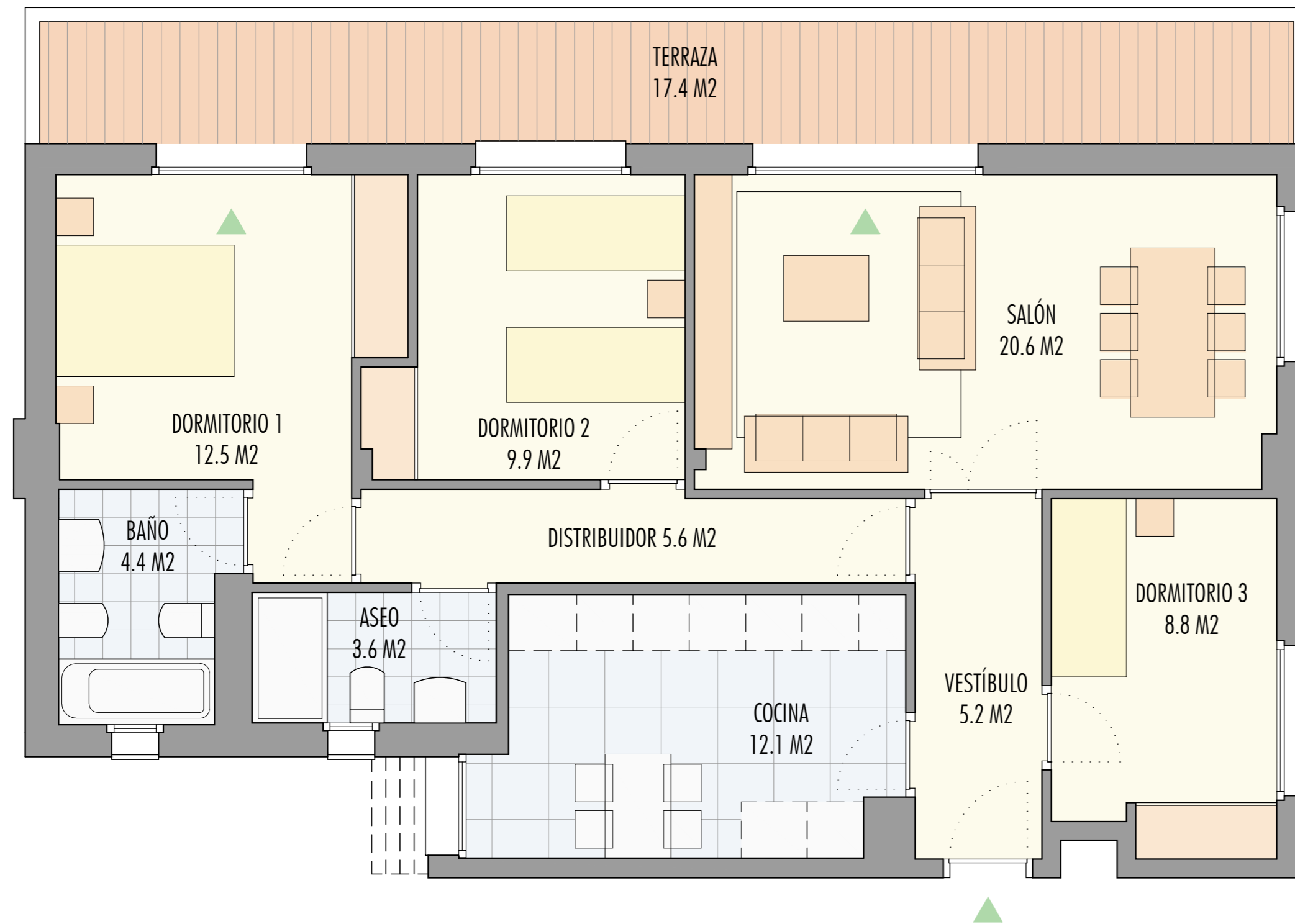

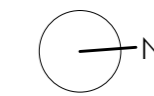
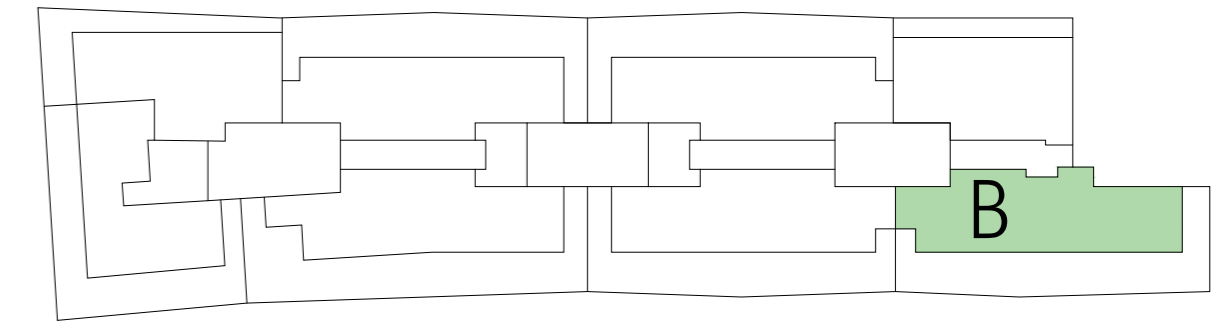

PLANTA 5
Portal 4 - Letra B

VIVIENDA TIPO 19 / 4D

superficie CONSTRUIDA - C/PPEC: 127,74 M²

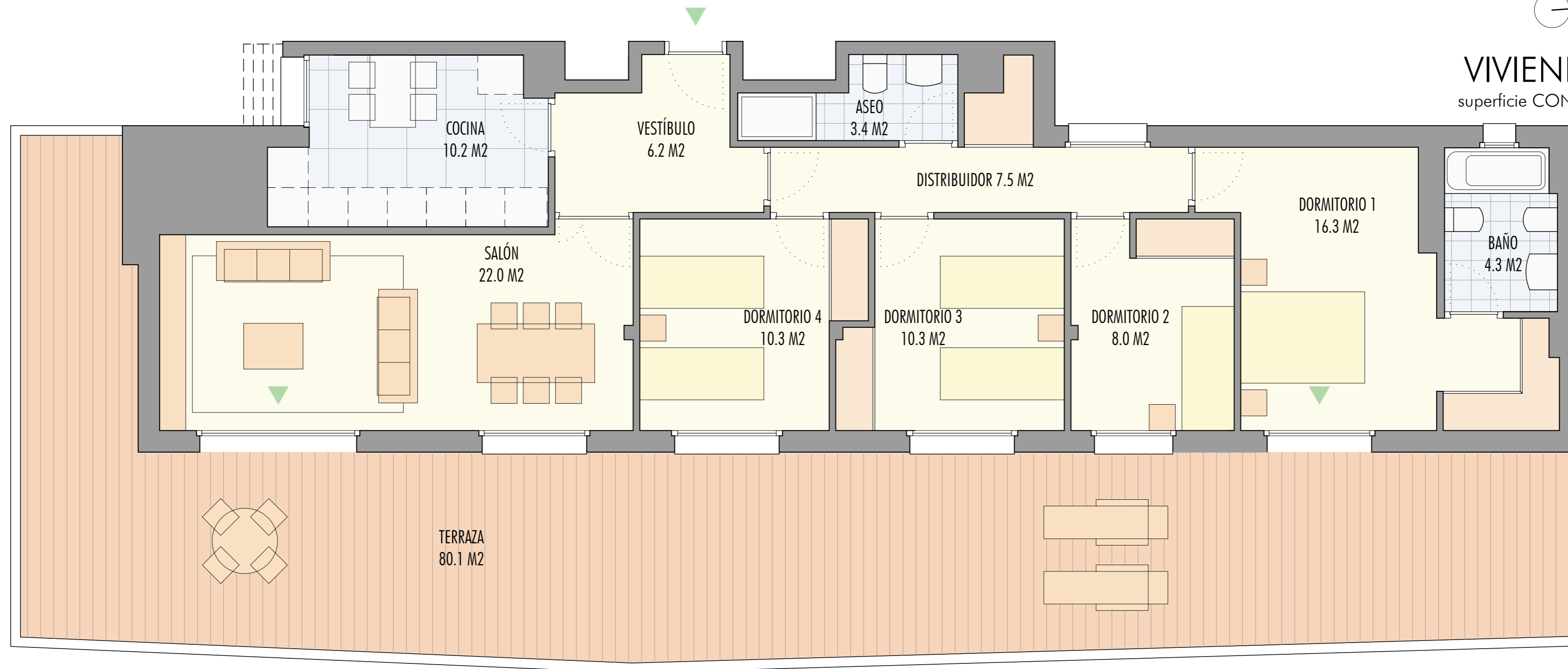

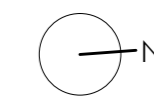
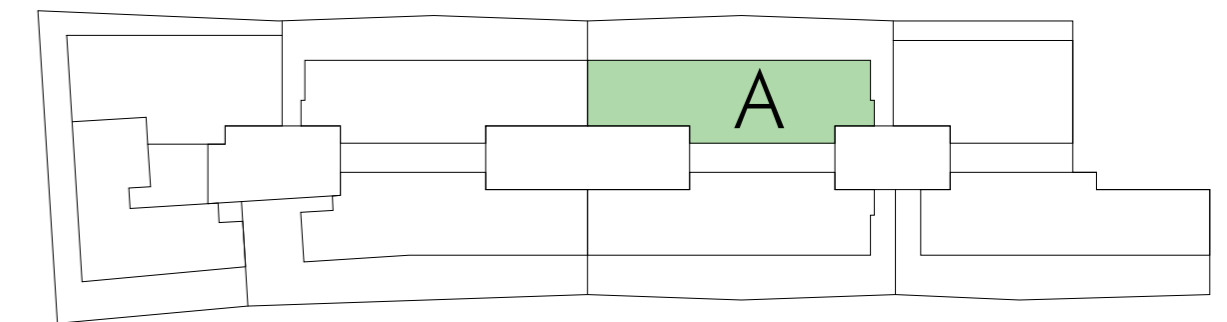

PLANTA 5
Portal 3 - Letra A

VIVIENDA TIPO 7* / 4D

superficie CONSTRUIDA - C/PPEC: M2

